

LOCALITY PLAN
SCALE 1 : 63 360

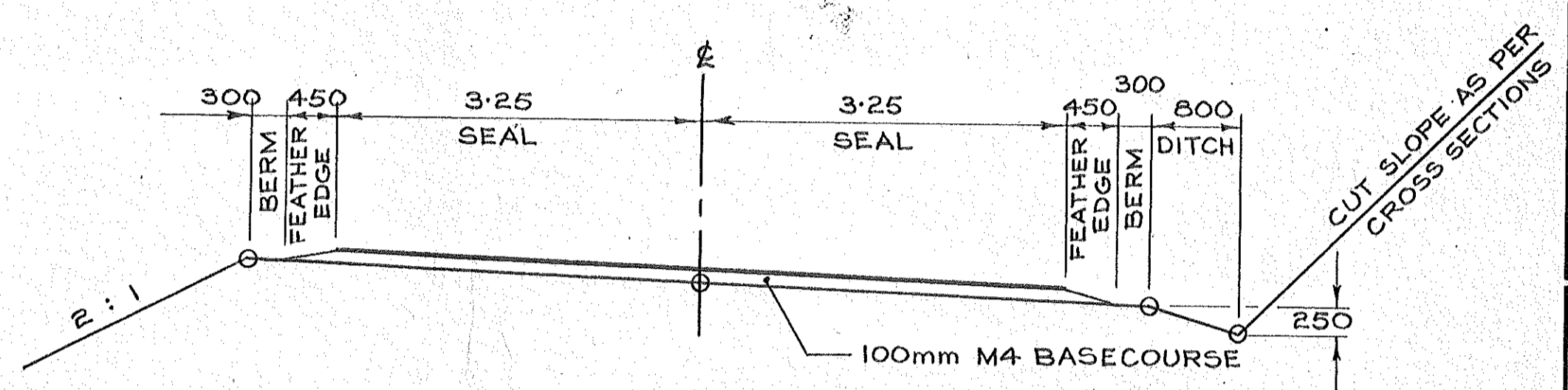

TYPICAL CROSS SECTION
SCALE 1 : 50

ADVANCE COPY

INDEX

- 1 INDEX, LOCALITY PLAN & ROAD DEVIATION DETAILS
- 2 ROAD DEVIATION CROSS SECTIONS 240.00 - 320.00
- 3 ROAD DEVIATION CROSS SECTIONS 340.00 - 400.00
- 4 LAUNCHING RAMP PLAN & PROFILE
- 5 LAUNCHING RAMP CROSSSECTIONS 00 - 30.00
- 6 LAUNCHING RAMP CROSSSECTIONS 40.00 - 60.00

BASELINE COORDINATES

BASELINE STATION	COORDINATES	
	NORTH	EAST
240	661612.37	276377.41
260	661593.98	276369.56
280	661575.00	276363.26
300	661555.56	276358.57
320	661535.82	276355.43
340	661515.92	276353.37
360	661495.99	276351.80
380	661476.04	276350.28
400	661456.10	276348.77

LINDIS PEAK CIRCUIT
ORIGIN LINDIS PEAK 700000 N. 300000 E.

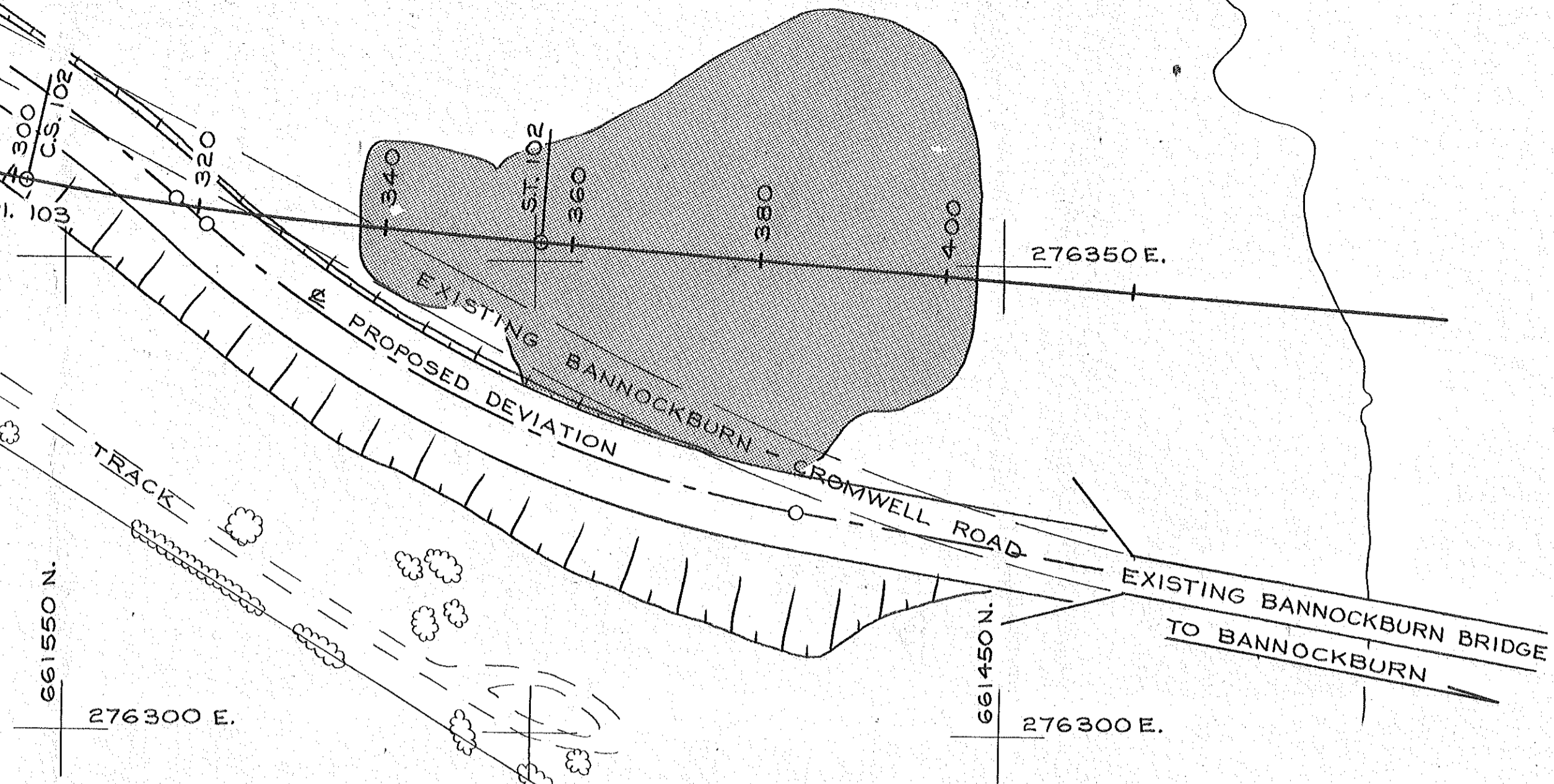

PLAN
SCALE 1 : 500

LEGEND
AREA REQUIRED FOR LAUNCHING RAMP

H.A.D. = 188.00		EXTENT OF DEVIATION												BRIDGE	
FINISHED SURFACE LEVEL	140 211.13	160 211.22	180 210.90	200 210.44	220 209.54	240 208.28	260 206.67	280 205.45	300 203.71	320 201.78	340 199.60	360 196.75	380 193.67	400 191.29	
BASELINE STATION	140	160	180	200	220	240	260	280	300	320	340	360	380	400	
BASELINE ALIGNMENT	CURVE 102														
	55.00 SPIRAL		240.00 RADIUS						55.00 SPIRAL		STRAIGHT				
CENTRELINE ALIGNMENT	STRAIGHT						CURVE 201	STRAIGHT	CURVE 202		STRAIGHT				
							170.00 RADIUS		130.00 RADIUS						

PROFILE

SCALE HORIZ. 1 : 1000
VERT. 1 : 200

DESIGNED	BY	CHECKED	DATE	R. L. PRESTON CHIEF CIVIL ENGINEER	Ministry of Works and Development	VINCENT COUNTY COUNCIL BANNOCKBURN BRIDGE ROAD DEVIATION & LAUNCHING RAMP INDEX, LOCALITY PLAN & ROAD DEVIATION DETAILS	ORIGINAL SCALES AS SHOWN	FILE		
DRAWN			8/86	J. C. RUTLEDGE ASSISTANT CHIEF CIVIL ENGINEER (DESIGN)			CIVIL ENGINEERING DUNEDIN			
DES. SUP'VD					CIVIL DESIGN OFFICE		JOB	CODE	SHEET	REVISION
DWG SUP'VD					T.G. SHADWELL Commissioner		7/573/7	7704	1	
RECOMMENDED	BY	APPD.	DATE	APPROVED						

ORIGINAL SIZE
A1

P.W. 482-A1

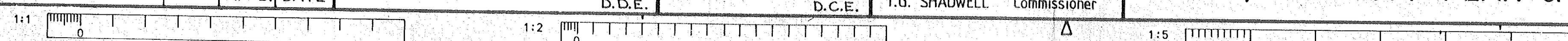

ORIGINAL SIZE 1:1 Whole numbers x mm

4
3
2
1
0
50
100
150
200
250
300
350
400
mm

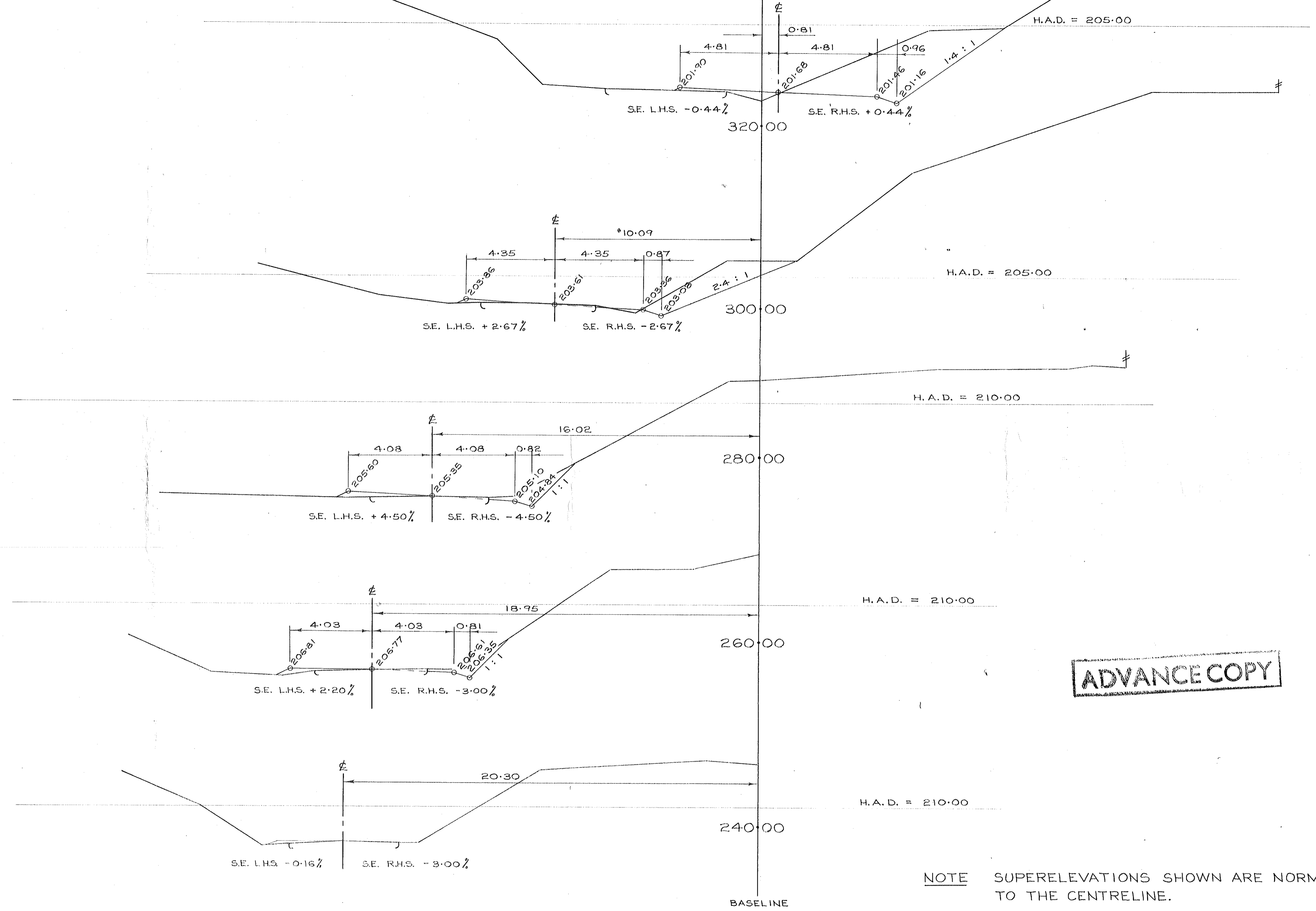

ADVANCE COPY

NOTE SUPERELEVATIONS SHOWN ARE NORMAL TO THE CENTRELINE.

DESIGNED		BY	CHECKED	DATE	R. L. PRESTON CHIEF CIVIL ENGINEER J. C. RUTLEDGE ASSISTANT CHIEF CIVIL ENGINEER (DESIGN) APPROVED T.G. SHADWELL Commissioner	 Ministry of Works and Development CIVIL ENGINEERING DUNEDIN CIVIL DESIGN OFFICE	VINCENT COUNTY COUNCIL		ORIGINAL SCALES	FILE		
DRAWN				8/86			BANNOCKBURN BRIDGE		1 : 100			
DES. SUP'VD							ROAD DEVIATION & LAUNCHING RAMP		JOB	CODE	SHEET	REVISION
DWG SUP'VD							ROAD DEVIATION CROSSECTIONS 240.00 - 320.00		7/573/7	7704	2	
RECOMMENDED					D.C.E.							
AMENDMENTS		BY	APPD.	DATE	D.C.E.							

4
300
3
200
2
150
2
100
1
50
1
0
m m

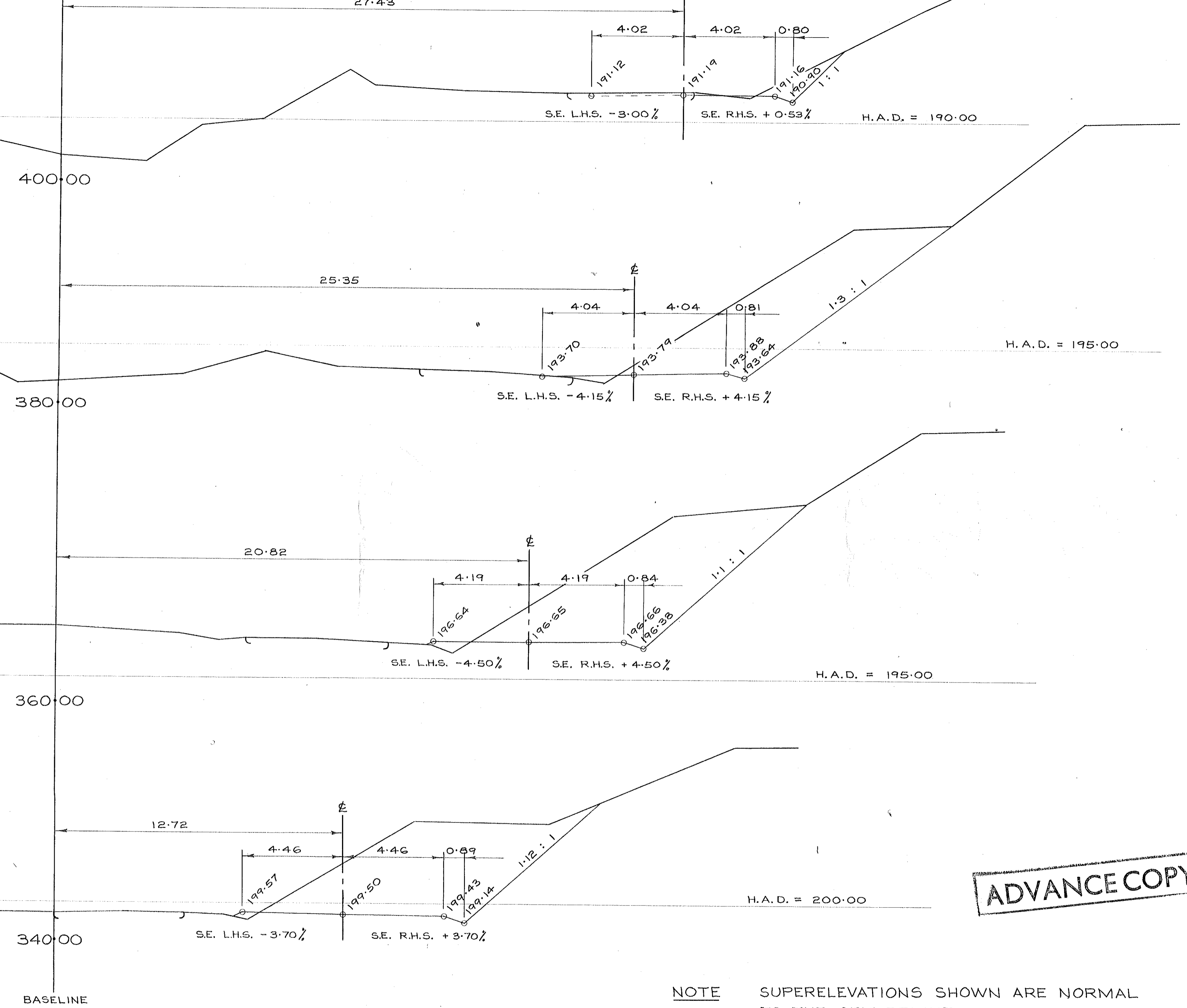

ADVANCE COPY

NOTE SUPERELEVATIONS SHOWN ARE NORMAL TO THE CENTRELINE.

				DESIGNED	BY	CHECKED	DATE	R. L. PRESTON CHIEF CIVIL ENGINEER		 Ministry of Works and Development	VINCENT COUNTY COUNCIL BANNOCKBURN BRIDGE ROAD DEVIATION & LAUNCHING RAMP ROAD DEVIATION CROSS SECTIONS 340.00 - 400.00			ORIGINAL SCALES 1:100	FILE		
				DRAWN			8/86	J. C. RUTLEDGE ASSISTANT CHIEF CIVIL ENGINEER (DESIGN)			CIVIL ENGINEERING DUNEDIN						
				DES. SUP'VD				APPROVED		CIVIL DESIGN OFFICE				JOB	CODE	SHEET	REVISION
				DWG. SUP'VD				D.C.E.		T.G. SHADWELL Commissioner				7/573/7	7704	3	
AMENDMENTS				BY	APPD.	DATE	D.D.E.										

ORIGINAL SIZE A1

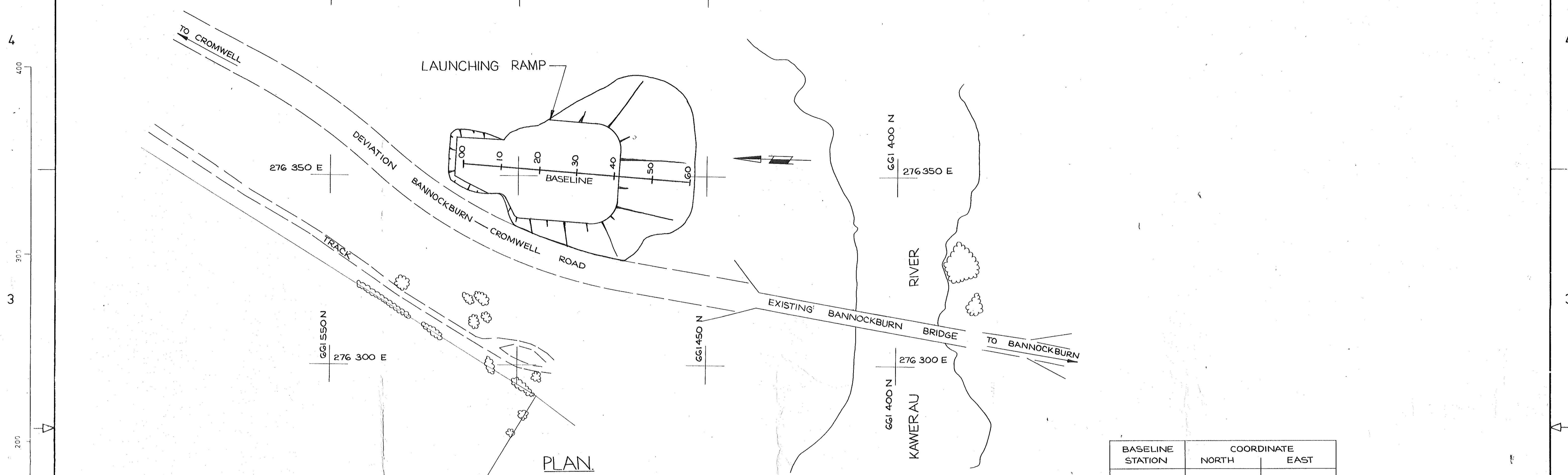

PLAN
SCALE 1:500

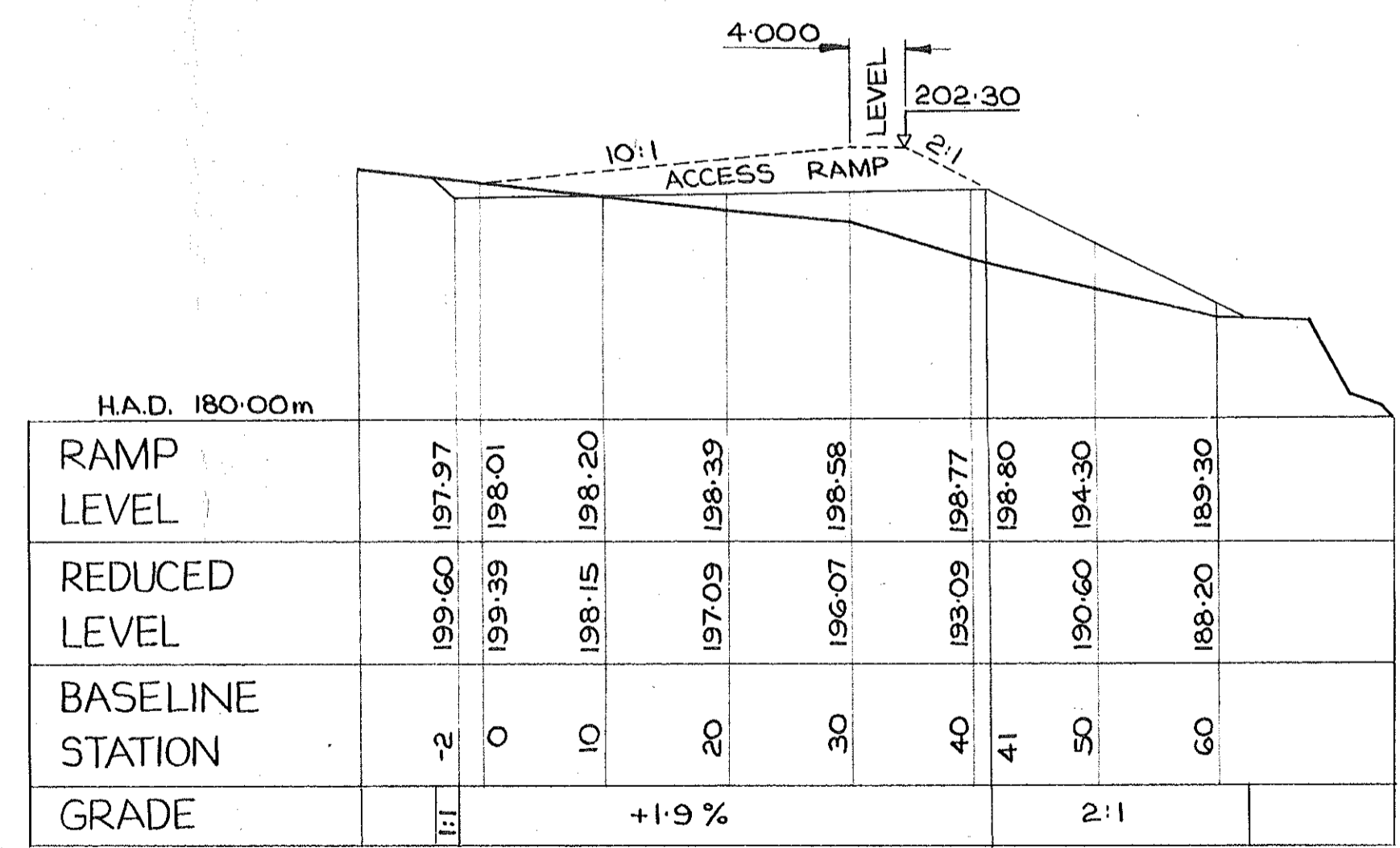

LAUNCHING RAMP PROFILE
SCALE 1:500

BASELINE STATION	COORDINATE	
	NORTH	EAST
00	661 514.38	276 352.99
10	661 504.31	276 352.25
20	661 494.44	276 351.53
30	661 484.46	276 350.80
40	661 474.59	276 350.11
50	661 464.51	276 349.34
60	661 454.54	276 348.61

NOTE :- COORDINATES IN TERMS OF LINDIS PEAK CIRCUIT

ADVANCE COPY

DESIGN	BY	CHECKED	DATE	R. L. PRESTON CHIEF CIVIL ENGINEER		VINCENT COUNTY COUNCIL BANNOCKBURN BRIDGE ROAD DEVIATION & LAUNCHING RAMP LAUNCHING RAMP PLAN & PROFILE	ORIGINAL SCALES	AS SHOWN	FILE		
	DRAWN						J. C. RUTLEDGE ASSISTANT CHIEF CIVIL ENGINEER (DESIGN)	CIVIL ENGINEERING DUNEDIN			
	DES. SUP.							CIVIL DESIGN OFFICE			
D.W.G. SUP.				APPROVED	T.G. SHADWELL Commissioner		JOB	CODE	SHEET	REVISION	
RECOMMENDED							7/573/7	7704	4		
AMENDMENTS	BY	APPD.	DATE	D.D.E.	D.C.E.						

4
300
3
200
2
150
100
50
1
0
m m

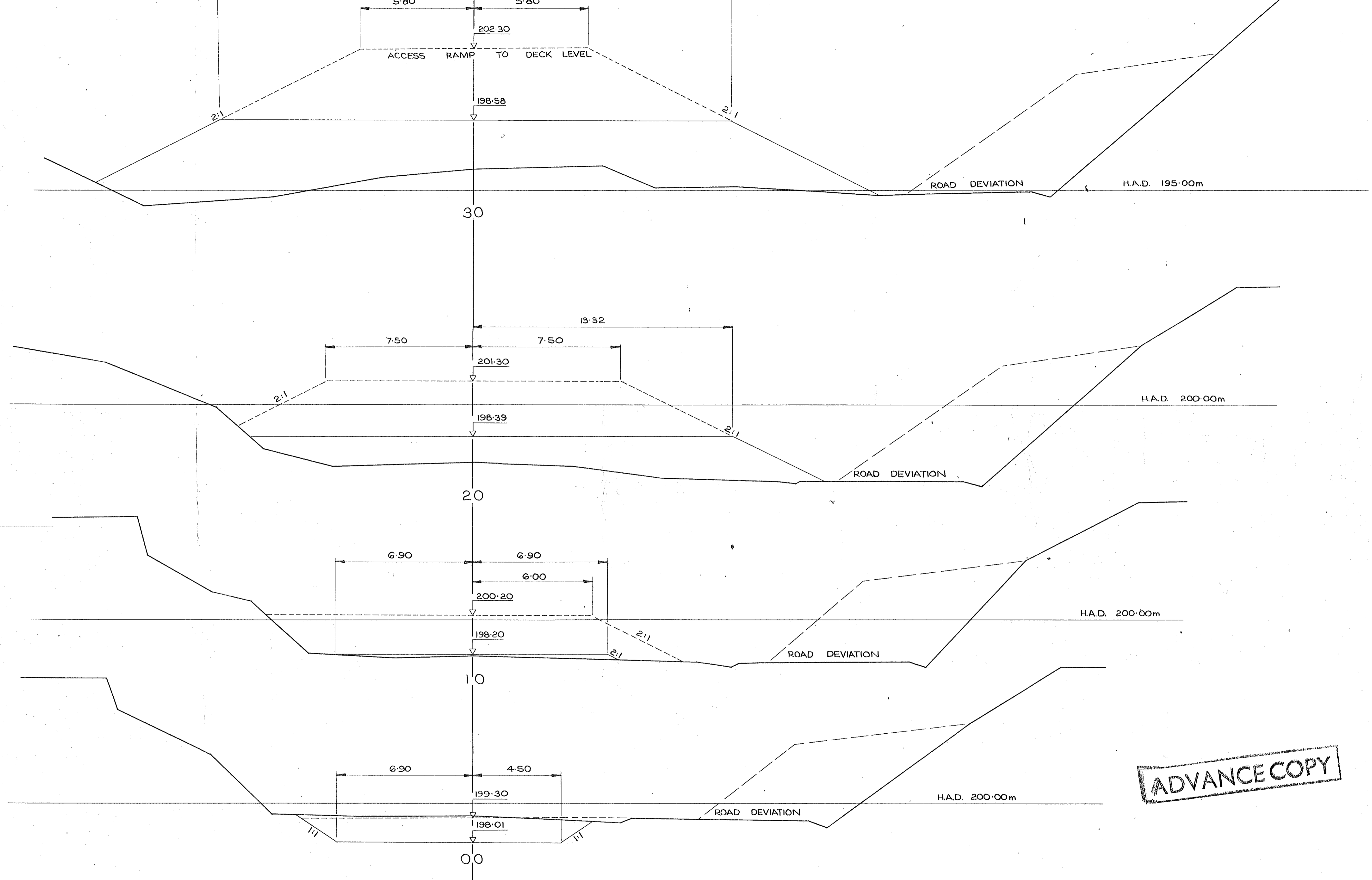

ADVANCE COPY

DESIGN		BY	CHECKED	DATE	R. L. PRESTON CHIEF CIVIL ENGINEER	Ministry of Works and Development	VINCENT COUNTY COUNCIL BANNOCKBURN BRIDGE ROAD DEVIATION & LAUNCHING RAMP LAUNCHING RAMP CROSS SECTIONS 00—30	ORIGINAL SCALES AS SHOWN		FILE
DRAWN								CIVIL ENGINEERING DUNEDIN		JOB
DES. SUR					J. C. RUTLEDGE ASSISTANT CHIEF CIVIL ENGINEER (DESIGN)	CIVIL DESIGN OFFICE	7/573/7	7704	5	
DWG. SUR										
RECOMMENDED					APPROVED	DC.E.				
AMENDMENTS		BY	APPD.	DATE	D.D.E.					

4
3
2
1
0
50
100
150
200
300
400
mm

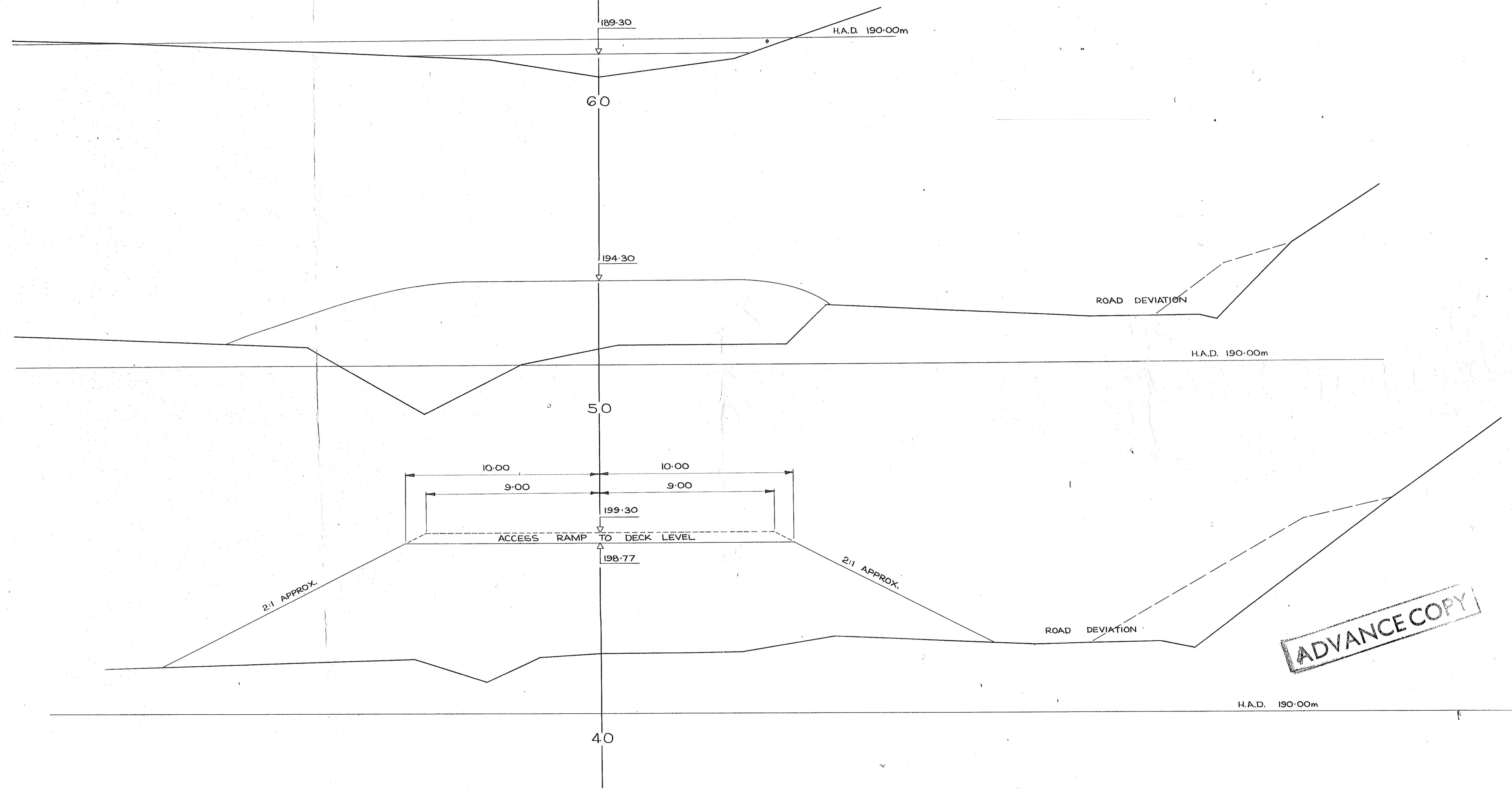

ADVANCE COPY

DESIGN		BY	CHECKED	DATE	R. L. PRESTON CHIEF CIVIL ENGINEER	Ministry of Works and Development	VINCENT COUNTY COUNCIL BANNOCKBURN BRIDGE ROAD DEVIATION & LAUNCHING RAMP LAUNCHING RAMP CROSS SECTIONS 40—60	ORIGINAL SCALES	AS SHOWN	FILE	
DRAWN								J. C. RUTLEDGE ASSISTANT CHIEF CIVIL ENGINEER (DESIGN)	CIVIL ENGINEERING DUNEDIN		
DES. SUP					J. C. RUTLEDGE ASSISTANT CHIEF CIVIL ENGINEER (DESIGN)	CIVIL DESIGN OFFICE		JOB	CODE	SHEET	REVISION
DWS. SUP					APPROVED	T.G. SHADWELL Commissioner		7/573/7	7704	6	
RECOMMENDED					D.D.E.	D.C.E.					
AMENDMENTS		BY	APPD.	DATE							

P.W. 482-A1

LOCAL OR TRACING No.

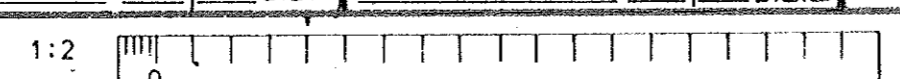

ORIGINAL SIZE A1

Whole numbers = mm
Decimalised expressions = m